

# IL280 Series

## LED Parking Garage Lighting



### Advantages of IL280

- Compact, low profile LED parking light
- Available in 35 / 55 / 75Watt configurations with various optics
- Ultra-bright industry leading high efficacy up to 187 lm / W
- Proprietary reflector optics enabling glare-free uniform lighting, eliminating the need for costly and fragile plastic lenses
- Advanced thermal technology enables low LED junction temperatures (Tj) for maintenance free long life
- Optional wireless smart control system with motion & daylight sensor enabling greater savings and flexibility
- IP68 rated tri-proof (dust, vapor & water-proof) luminaire
- Available with versatile mounting options for various flood applications
- Titanium rated high efficiency LED driver with smart circuitry
- L70 ≥ 145,000 hours with an exceptional 10-year limited warranty
- Designed and engineered in the USA

### Applications

- Multi-level Parking Garages
- Underground Parking Garage
- Carports & Garages



Years Warranty



Smart Control



Wet Location



Impact Resistance

# IL280 Series

## LED Parking Garage Lighting

### Optics Options

**R5 - Type V Round** / symmetric for mid-low bay, parking garages and flood applications

---

**M - Medium**

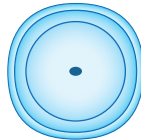

**S5 - Type V Square** / symmetric for mid-low bay, aisle and flood applications

---

**S - Short**

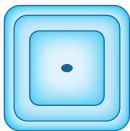

**F5 - Type V Opaque - Frosted** / symmetric for ultra uniform & low glare applications

---

**L - Long**

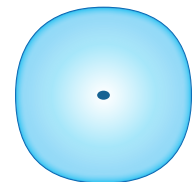

**WC - Well Glass - Clear** / spherical symmetric for area lighting, parking garages and wide flood applications

---

**M - Medium**

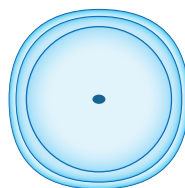

**WF - Well Glass - Frosted** / spherical symmetric for ultra uniform & low glare applications

---

**L - Long**

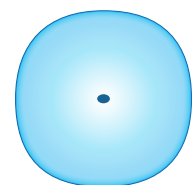

# IL280 Series

## LED Parking Garage Lighting

### Mounting Options



#### Pendant Mounting System

Part Number	Part Description
PDS-IL28	Pendant Mounting Interface / 3/4" Pipe Not Included



#### Snap & Turn Surface Mounting System

Part Number	Part Description
SST-IL28-B	Snap & Turn Surface Mount Bracket / Steel Black

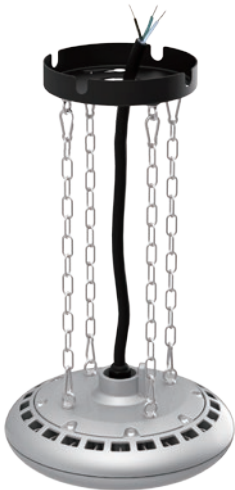

#### Chain Chandelier Mounting System

Part Number	Part Description
CH4-IL28-45C	4 Link Chain Chandelier System / 18" (45cm) / Chrome Steel
CH4-IL28-90C	4 Link Chain Chandelier System / 36" (90cm) / Chrome Steel



#### Swivel Mounting System

Part Number	Part Description
SWL-IL28-SS	Variable Angle Swivel Mounting Bracket / Stainless Steel

# IL280 Series

## LED Parking Garage Lighting - 75Watt

### Ordering Information

IL28	Wattage	Voltage	Optics	Pitch	CCT	Driver & Control *	Mounting **
	035 = 35Watt 055 = 55Watt 075 = 75Watt	UV = 100-277VAC HV = 200-480VAC DV = 127-390VDC	R5 = Type V Round S5 = Type V Square F5 = Type V Frosted WC = Well Glass Clear WF = Well Glass Frosted	S = Short M = Medium L = Long	30 = 3000K 40 = 4000K 50 = 5000K	ND = Non-Dimmable DM = Dimmable DS = Daylight Sensor MS = Motion Sensor SC = Smart Control	PDS = Pendant Mount SST = Snap & Turn Mount CH4 = 4 Chain Mount SWL = Swivel Mount

NOTE: Gray is the standard exterior color.

\* Smart control & daylight sensor available with ZHAGA standard receptacle module.

\*\* PDS is the standard mounting system, with 1" NPT threaded hole.

### Example

Part Number	Part Description
IL28075UV-R5M-50DM-PDS	IL280 LED Parking Light / 75 Watt / 100-277VAC / Type V Round / Medium Pitch / 5000K Cool White / Dimmable / Pendant Mount

### External Dimensions

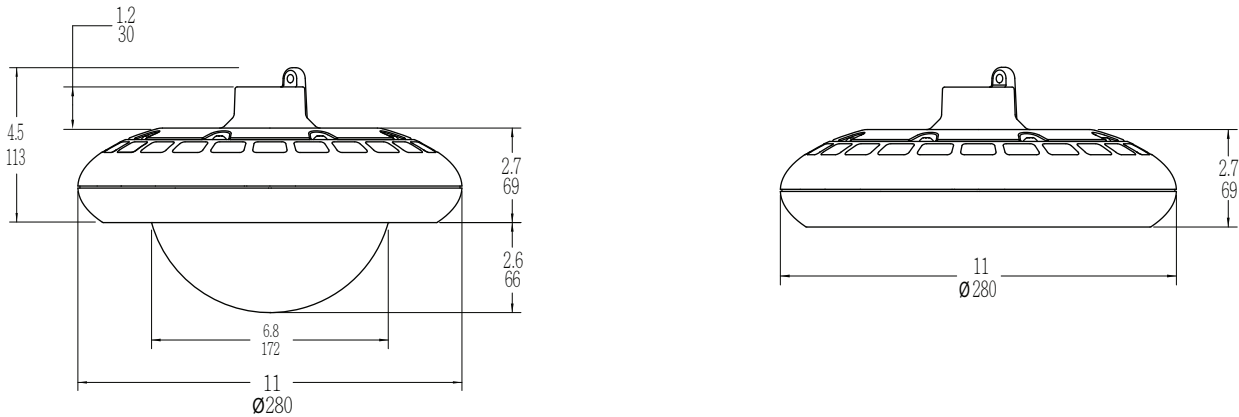

### Packaging Information

Model	Case Quantity	Dimensions (LxWxH)	Weight
IL280	1	30 x 30 x 13.3 cm 11.2 x 11.2 x 5.3 in	3.9 kg 8.6 lbs
IL280 Well Glass	1	30 x 30 x 20 cm 11.2 x 11.2 x 7.8 in	4 kg 8.8 lbs



# IL280 Series

LED Parking Garage Lighting - 75Watt

## Specification - Type V Round Medium / Well Glass Clear Medium

Fixture Watts	75 W
Lumens (Total) *	13,050 lm
Efficacy *	174 lm / W
Number of LEDs & Driving Current	64@385mA
Ts - Solder Point Temp*	62°C / 144°F
L70 Rating @ Ta 25°C	>145K Hours
Operational Temperature (Ta)	-40° ~ 50°C / -40° ~ 122°F
Input Voltage	100~277VAC 47~63Hz Optional 200~480VAC / 127~390VDC
LED Model	Nichia / Lumileds / Cree
CRI	>75
Lighting Control	Dimmable (0-10V, PWM) / Smart Control / Daylight & Motion Sensor
Warranty	10-Year Limited
Storage Temperature / Humidity	-50° ~ 80°C / -58° ~ 176°F / IP68 Rated Fixture
Transient Surge Protection	6kV / 3kA ( L-L, L-G )

\* Test data @ Ta: 25°C. All lumen values have ±7% tolerance  
NOTE: Light intensities measured directly below fixture

### Light Distribution Curve

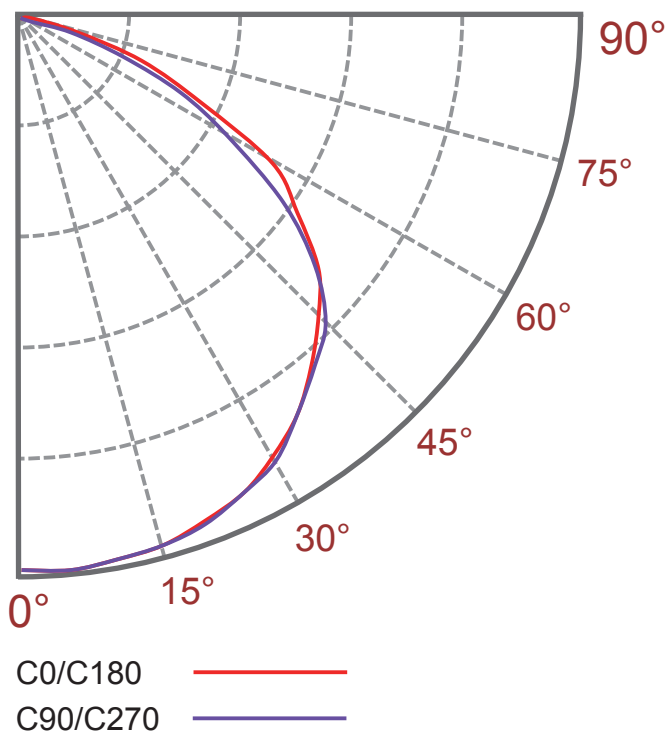

### Zonal Lumen Summary

Zone (°)	Lumens	% Fixture
0-30	3576	27.4%
0-40	6016	46.1%
0-60	11171	85.6%
0-90	13050	100.0%
0-180	13050	100.0%

# IL280 Series

## LED Parking Garage Lighting - 75Watt

### Specification - Type V Square Short

Fixture Watts	75 W
Lumens (Total) *	12,450 lm
Efficacy *	166 lm / W
Number of LEDs & Driving Current	64@385mA
Ts - Solder Point Temp*	62°C / 144°F
L70 Rating @ Ta 25°C	>145K Hours
Operational Temperature (Ta)	-40° ~ 50°C / -40° ~ 122°F
Input Voltage	100~277VAC 47~63Hz Optional 200~480VAC / 127~390VDC
LED Model	Nichia / Lumileds / Cree
CRI	>75
Lighting Control	Dimmable (0-10V, PWM) / Smart Control / Daylight & Motion Sensor
Warranty	10-Year Limited
Storage Temperature / Humidity	-50° ~ 80°C / -58° ~ 176°F / IP68 Rated Fixture
Transient Surge Protection	6kV / 3kA ( L-L, L-G )

\* Test data @ Ta: 25°C. All lumen values have ±7% tolerance  
NOTE: Light intensities measured directly below fixture

### Light Distribution Curve

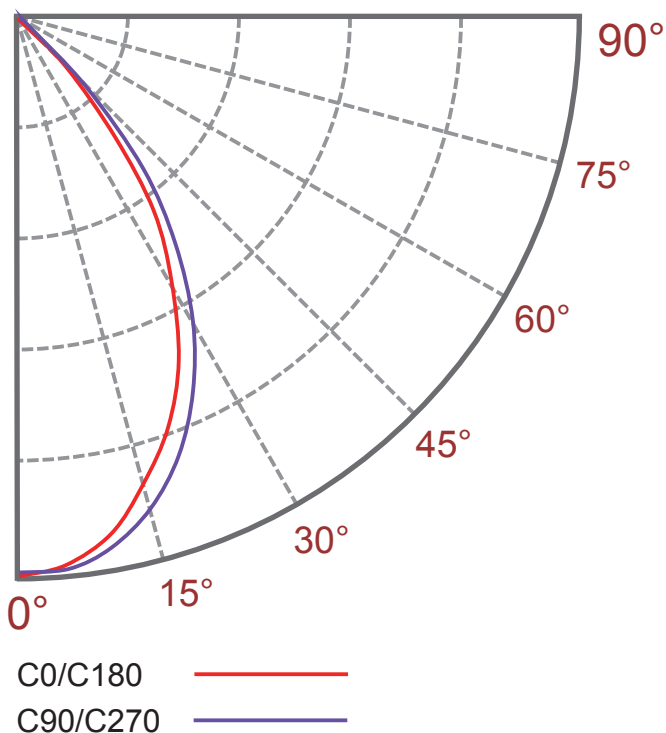

### Zonal Lumen Summary

Zone (°)	Lumens	% Fixture
0-30	7445	59.8%
0-40	10645	85.5%
0-60	12438	99.9%
0-90	12450	100.0%
0-180	12450	100.0%

# IL280 Series

## LED Parking Garage Lighting - 75Watt

### Specification - Type V Frosted Long / Well Glass Frosted Long

Fixture Watts	75 W
Lumens (Total) *	11,475 lm
Efficacy *	153 lm / W
Number of LEDs & Driving Current	64@385mA
Ts - Solder Point Temp*	64°C / 147°F
L70 Rating @ T <sub>a</sub> 25°C	>145K Hours
Operational Temperature (T <sub>a</sub> )	-40° ~ 50°C / -40° ~ 122°F
Input Voltage	100~277VAC 47~63Hz Optional 200~480VAC / 127~390VDC
LED Model	Nichia / Lumileds / Cree
CRI	>75
Lighting Control	Dimmable (0-10V, PWM) / Smart Control / Daylight & Motion Sensor
Warranty	10-Year Limited
Storage Temperature / Humidity	-50° ~ 80°C / -58° ~ 176°F / IP68 Rated Fixture
Transient Surge Protection	6kV / 3kA ( L-L, L-G )

\* Test data @ T<sub>a</sub>: 25°C. All lumen values have ±7% tolerance  
 NOTE: Light intensities measured directly below fixture

### Light Distribution Curve

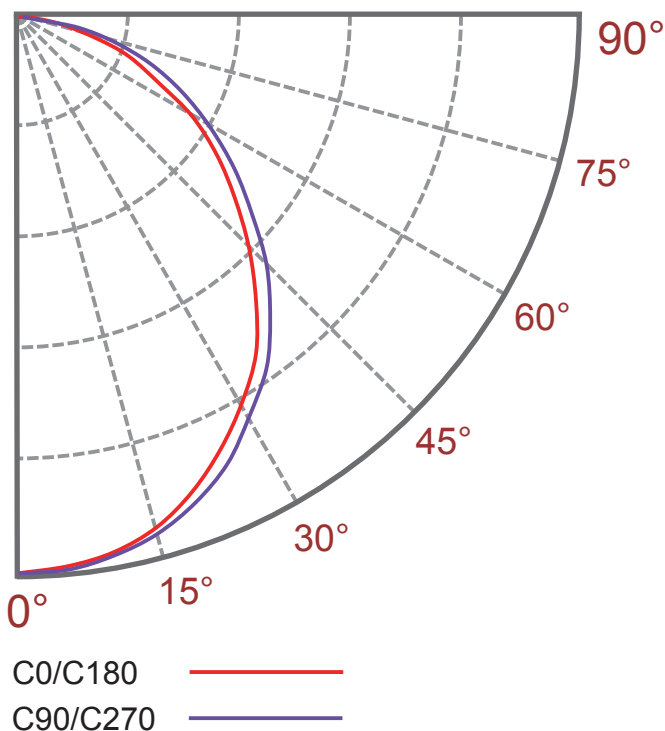

### Zonal Lumen Summary

Zone (°)	Lumens	% Fixture
0-30	3374	29.4%
0-40	5439	47.4%
0-60	9272	80.8%
0-90	11441	99.7%
0-180	11475	100.0%