

IL3525 Series

LED Parking Garage Lighting



Advantages of IL3525

- Technologically advanced, low profile LED parking light
- Available in 35 ~ 100Watt configurations with various optics
- Ultra-bright industry leading high efficacy up to 150 lm / W
- Proprietary reflector optics enabling glare-free uniform lighting for all working environments, eliminating the need for costly and fragile plastic lenses
- Advanced thermal technology enables low LED junction temperatures (Tj) for maintenance free long life
- IP68 rated tri-proof (dust, vapor & water-proof) luminaire
- Ultra-wide angle butterfly optics reducing required fixtures by up to 25%
- Optional wireless smart control system with motion & daylight sensor enabling greater savings and flexibility
- Available with versatile mounting options for various parking structure applications
- Titanium rated high efficiency LED driver with smart circuitry
- L70 ≥ 135,000 hours with an exceptional 10-year limited warranty
- Designed and engineered in the USA



Years Warranty



Smart Control



Wet Location



Impact Resistance

Applications

- Single level Parking Garage
- Multi-level Parking Garage
- Underground Parking Garage
- Carports
- Garages

IL3525 Series

LED Parking Garage Lighting

Optic Options

02 - Type II / wall mount & perimeter lighting applications

M - Medium

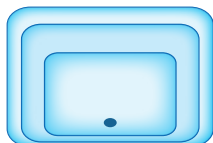

S5 - Type V Rectangular / symmetric for canopies, tunnels, parking garages and wide flood applications

M - Medium

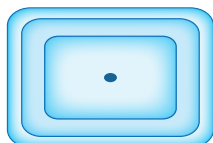

F5 - Type V Opaque - Frosted / symmetric for ultra uniform & low glare applications

L - Long

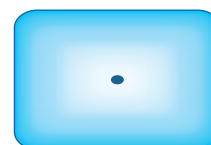

IL3525 Series

LED Parking Garage Lighting

Mounting Options



Pendant Mounting System

Part Number	Part Description
PDS-IL35	Pendant Mounting Interface / 3/4" Pipe Not Included



Snap & Slide Surface Mounting System

Part Number	Part Description
SSL-IL3525-B	Snap & Slide Surface Mount Bracket / Steel Black



Chain Mounting System

Part Number	Part Description
CH4-IL3525-45C	4 Link Chain Chandelier System / 18" (45cm) / Chrome Steel
CH4-IL3525-90C	4 Link Chain Chandelier System / 36" (90cm) / Chrome Steel



Swivel Mounting System

Part Number	Part Description
SWL-IL3525-SS	Variable Angle Swivel Mounting Bracket / Stainless Steel

IL3525 Series

LED Parking Garage Lighting - 55Watt

Ordering Information

IL3525 -	Wattage	Voltage	Optics	Pitch	CCT	Driver & Control *	Mounting **
	035 = 35Watt 055 = 55Watt 075 = 75Watt 100 = 100Watt	UV = 100-277VAC HV = 200-480VAC DV = 127-390VDC	02 = Type II S5 = Type V Rectangular F5 = Type V Frosted	M = Medium L = Long	30 = 3000K 40 = 4000K 50 = 5000K	ND = Non-Dimmable DM = Dimmable DS = Daylight Sensor MS = Motion Sensor SC = Smart Control	PDS = Pendant Mount SSL = Snap & Slide Mount CH4 = 4 Chain Mount SWL = Swivel Mount

NOTE: Gray is the standard exterior color.

* Smart control & daylight sensor available with ZHAGA standard receptacle module.

** PDS is the standard mounting system, with 1" NPT threaded hole.

Example

Part Number	Part Description
IL3525-055UV-S5M-50ND-SSL	LED Parking Light / 55 Watt / 100-277VAC / Type V Rectangular / Medium Pitch / 5000K Cool White / Non-Dimmable / Snap & Slide Mount

External Dimensions

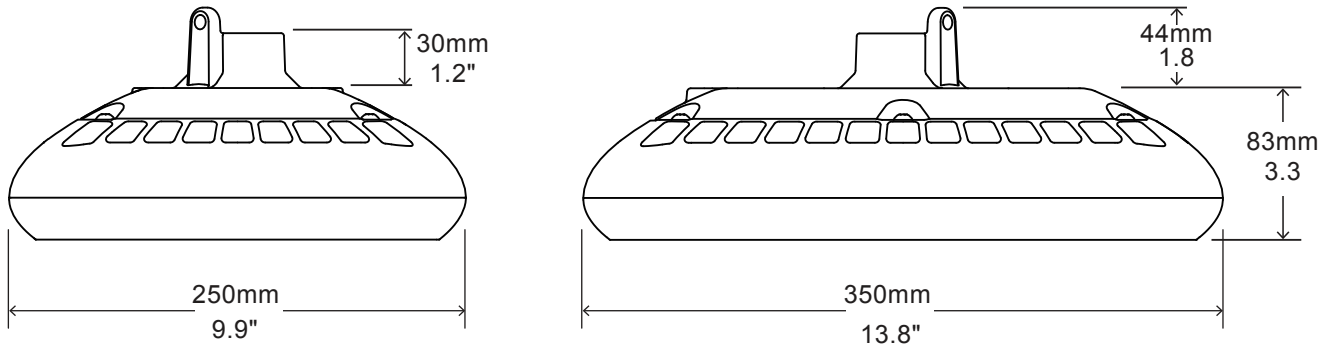

Packaging Information

Case Quantity	Dimensions (LxWxH)	Weight
1	38.5 x 28.5 x 16.5 cm 15.2 x 11.25 x 6.5 in	5.7 kg 12.5 lbs



IL3525 Series

LED Parking Garage Lighting - 55Watt

Specification - Type II Medium

Fixture Watts	55 W
Lumens (Total) *	7,865 lm
Efficacy *	143 lm / W
Number of LEDs & Driving Current	48@370mA
T _s - Solder Point Temp *	56°C / 133°F
L70 Rating @ T _a 25°C	> 160K hours
Operational Temperature (T _a)	-40° ~ 50°C / -40° ~ 122°F
Input Voltage	100~277VAC 47~63Hz Optional 200~480VAC / 127~390VDC
LED Model	Lumileds / Nichia / Cree
CRI	>75
Lighting Control	Dimmable (0-10V, PWM) / Smart Control / Daylight & Motion Sensor
Warranty	10-Year Limited
Storage Temperature / Humidity	-50° ~ 80°C / -58° ~ 176°F / IP68 Rated Fixture
Transient Surge Protection	6kV / 3kA (L-L, L-G)

* Test data @ T_a: 25°C. All lumen values have ±7% tolerance

NOTE: Light intensities measured directly below fixture

Light Distribution Curve

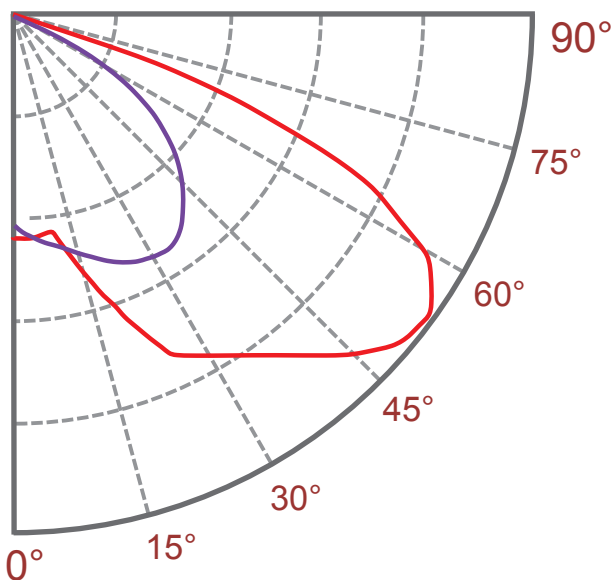

C0/C180 —
 C90/C270 —

Zonal Lumen Summary

Zone (°)	Lumens	% Fixture
0-30	2533	32.2%
0-40	4570	58.1%
0-60	7338	93.3%
0-90	7818	99.4%
0-180	7865	100.0%

IL3525 Series

LED Parking Garage Lighting - 55Watt

Specification - Type V Rectangular

Fixture Watts	55 W
Lumens (Total) *	8,030 lm
Efficacy *	146 lm / W
Number of LEDs & Driving Current	48@370mA
T _s - Solder Point Temp *	54°C / 131°F
L70 Rating @ T _a 25°C	> 160K hours
Operational Temperature (T _a)	-40° ~ 50°C / -40° ~ 122°F
Input Voltage	100~277VAC 47~63Hz Optional 200~480VAC / 127~390VDC
LED Model	Lumileds / Nichia / Cree
CRI	>75
Lighting Control	Dimmable (0-10V, PWM) / Smart Control / Daylight & Motion Sensor
Warranty	10-Year Limited
Storage Temperature / Humidity	-50° ~ 80°C / -58° ~ 176°F / IP68 Rated Fixture
Transient Surge Protection	6kV / 3kA (L-L, L-G)

* Test data @ T_a: 25°C. All lumen values have ±7% tolerance

NOTE: Light intensities measured directly below fixture

Light Distribution Curve

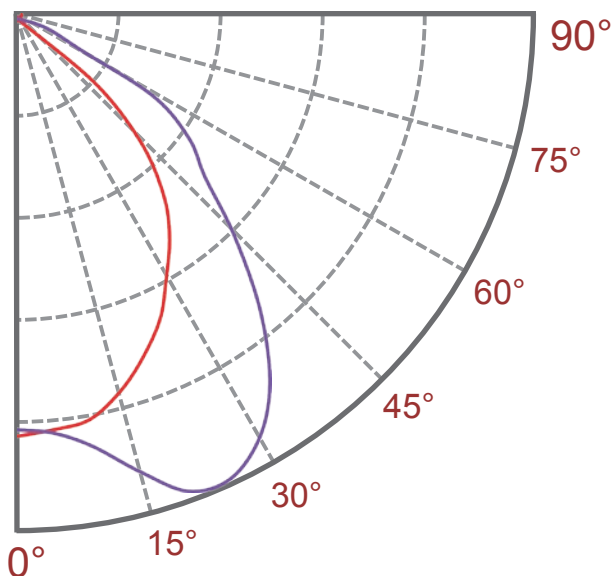

C0/C180 —
 C90/C270 —

Zonal Lumen Summary

Zone (°)	Lumens	% Fixture
0-30	3019	37.6%
0-40	4866	60.6%
0-60	7629	95.0%
0-90	8006	99.7%
0-180	8030	100.0%

IL3525 Series

LED Parking Garage Lighting - 55Watt

Specification - F5 Type V Frosted

Fixture Watts	55 W
Lumens (Total) *	7,315 lm
Efficacy *	133 lm / W
Number of LEDs & Driving Current	48@370mA
T _s - Solder Point Temp *	55°C / 131°F
L70 Rating @ T _a 25°C	> 160K hours
Operational Temperature (T _a)	-40° ~ 50°C / -40° ~ 122°F
Input Voltage	100~277VAC 47~63Hz Optional 200~480VAC / 127~390VDC
LED Model	Lumileds / Nichia / Cree
CRI	>75
Lighting Control	Dimmable (0-10V, PWM) / Smart Control / Daylight & Motion Sensor
Warranty	10-Year Limited
Storage Temperature / Humidity	-50° ~ 80°C / -58° ~ 176°F / IP68 Rated Fixture
Transient Surge Protection	6kV / 3kA (L-L, L-G)

* Test data @ T_a: 25°C. All lumen values have ±7% tolerance

NOTE: Light intensities measured directly below fixture

Light Distribution Curve

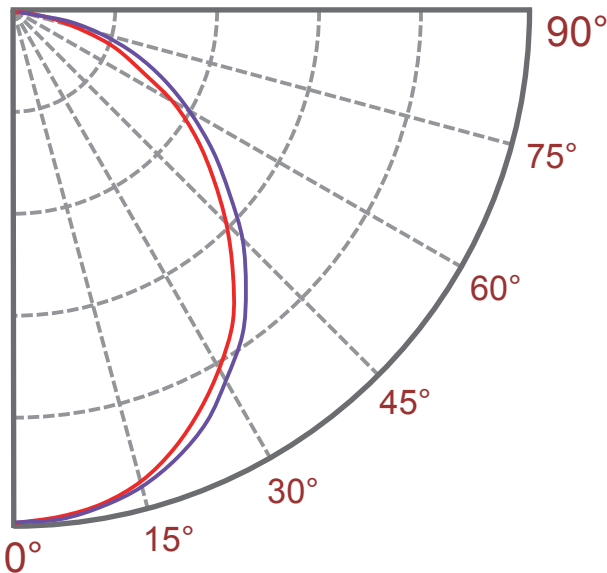

C0/C180 —
 C90/C270 —

Zonal Lumen Summary

Zone (°)	Lumens	% Fixture
0-30	2370	32.4%
0-40	3789	51.8%
0-60	6115	83.6%
0-90	7271	99.4%
0-180	7315	100.0%