

ILX340 Series

LED Corrosive Area Lighting



Advantages of ILX340

- Industries first true corrosion resistant LED fixture
- Available in 100 ~ 175 Watt configurations
- Ultra-bright, industry leading high efficacy up to 185 lm / W
- IP69K-rated tri-proof (dust, vapor & water-proof) light fixture, high pressure washable up to 1800PSI
- Advanced thermal technology enables low LED junction temperatures (Tj) for maintenance free long life
- Sloped curvature & smooth surface design prevents residue and bacteria build up
- Dual layer space age coating for unmatched corrosive resistance in acidic environments
- Corrosion resistant stainless steel SUS316 power connection portal for total protection
- Titanium rated high efficiency LED driver for unmatched reliability
- L70 ≥ 150,000 hours with an exceptional 7-year limited warranty
- Designed and engineered in the USA

Applications

- Marine & Ship Yards
- Desalination Plants
- Wastewater Treatment Plants
- Cement & Chemical Plants
- Offshore Oil & Gas
- Refineries
- Gas-to-Liquid (GTL) Plants
- Terminals & Tank Farms



Years Warranty



Wet Location



Pressure Washable



Impact Resistance



High Temperature



Hazardous Area



Corrosive Area



ILX340 Series

LED Corrosive Area Lighting

Optic Options

R5 - Type V Round / symmetric for low-mid-high bay, parking garages and flood applications

S - Short

M - Medium

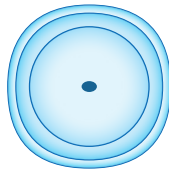

S5 - Type V Square / symmetric for high-bay, aisle, high-mast and flood applications

S - Short

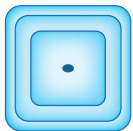

F5 - Type V Opaque - Frosted / symmetric for ultra uniform & low glare applications

L - Long

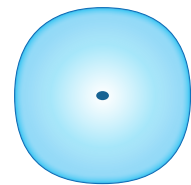

Mounting Options

Swivel Mounting System - SWL



PDS - Pendant Mounting System



ILX340 Series

LED Corrosive Area Lighting

Ordering Information

ILX34	Wattage	Voltage	Optics	Pitch	CCT	Driver & Control	Mounting *
	100 = 100W 125 = 125W 150 = 150W 175 = 175W	UV = 100-277VAC HV = 200-480VAC	R5 = Type V Round S5 = Type V Square F5 = Type V Frosted	S = Short M = Medium L = Long	30 = 3000K 40 = 4000K 50 = 5000K	ND = Non-Dimmable DM = Dimmable	PDS = Pendant Mount SWL = Swivel Mount

* PDS is the standard mounting system with 1" NPT threaded coupling.

Example

Part Number	Part Description
ILX34125UV-R5M-50DM-PDS	LED Corrosive Area Light / 125 Watt / 100-277VAC / Type V Round Medium / 5000K Cool White / Dimmable / Pendant Mount

External Dimensions

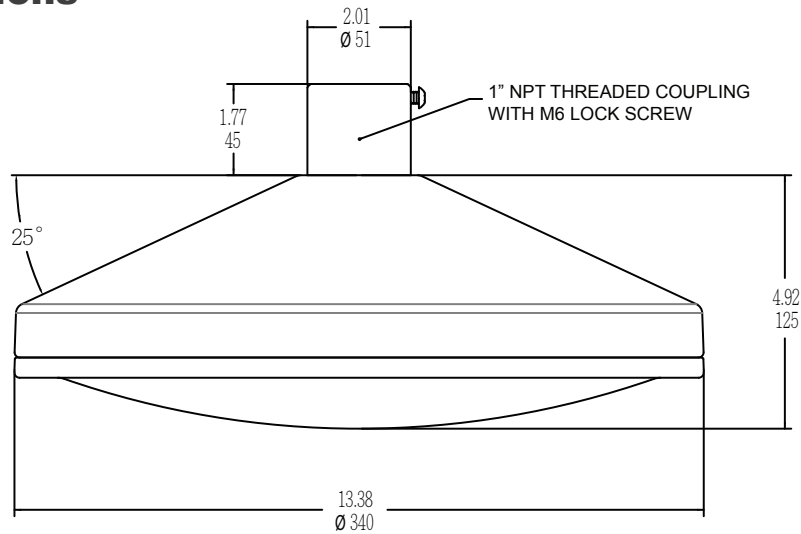

Packaging Information

Case Quantity	Dimensions (LxWxH)	Weight
1	36.5 x 36.5 x 20 cm 14.4 x 14.4 x 7.9 in	8.5 kg 18.70 lbs



ILX340 Series

LED Corrosive Area Lighting - 125Watt

Specification - Type V Round Medium

Fixture Watts	125 W
Lumens (Total) *	22,875 lm
Efficacy *	183 lm / W
Number of LEDs & Driving Current	128@355mA
T _s - Solder Point Temp *	56°C / 133°F
L70 Rating @ T _a 25°C	> 140K hours
Operational Temperature (T _a)	-40° ~ 60°C / -40° ~ 140°F
Input Voltage	100~277VAC 47~63Hz Optional 200~480VAC
LED Model	Nichia / Lumileds / Cree
CRI	> 75
Lighting Control	Dimmable (0-10V, PWM)
Storage Temp. / Humidity	-40° ~ 80°C / -40° ~ 176°F / IP69K Rated Fixture
Transient Surge Protection	10kV / 5kA (L-L, L-G) Optional 20kV / 10kA
Warranty	7-Year Limited

* Test data @ T_a: 25°C. All lumen values have ±7% tolerance
NOTE: Light intensities measured directly below fixture

Light Distribution Curve

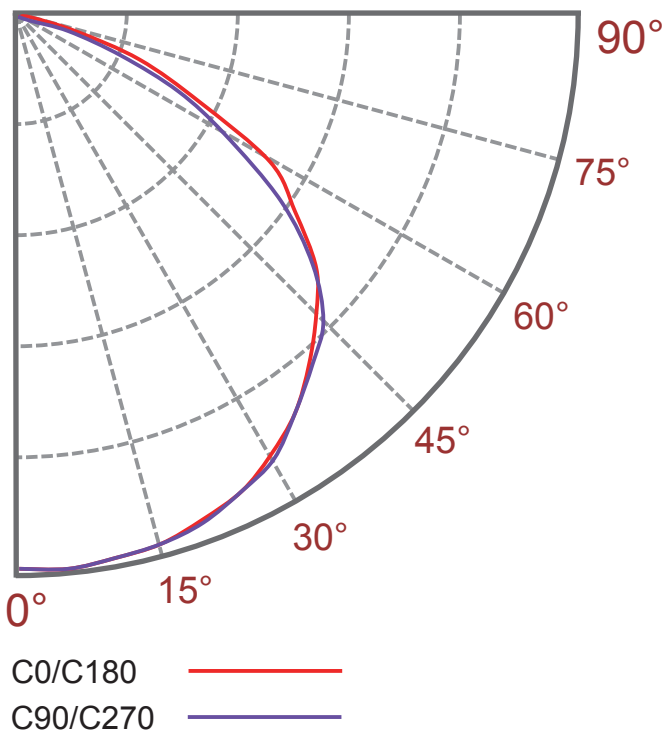

Zonal Lumen Summary

Zone (°)	Lumens	% Fixture
0-30	6,268	27.4%
0-40	10,545	46.1%
0-60	19,581	85.6%
0-90	22,875	100.0%
0-180	22,875	100.0%

ILX340 Series

LED Corrosive Area Lighting - 125Watt

Specification - Type V Square Short

Fixture Watts	125 W
Lumens (Total) *	22,375 lm
Efficacy *	179 lm / W
Number of LEDs & Driving Current	128@355mA
T _s - Solder Point Temp *	57°C / 135°F
L70 Rating @ T _a 25°C	> 137K hours
Operational Temperature (T _a)	-40° ~ 60°C / -40° ~ 140°F
Input Voltage	100~277VAC 47~63Hz Optional 200~480VAC
LED Model	Nichia / Lumileds / Cree
CRI	> 75
Lighting Control	Dimmable (0-10V, PWM)
Storage Temp. / Humidity	-40° ~ 80°C / -40° ~ 176°F / IP69K Rated Fixture
Transient Surge Protection	10kV / 5kA (L-L, L-G) Optional 20kV / 10kA
Warranty	7-Year Limited

* Test data @ T_a: 25°C. All lumen values have ±7% tolerance
NOTE: Light intensities measured directly below fixture

Light Distribution Curve

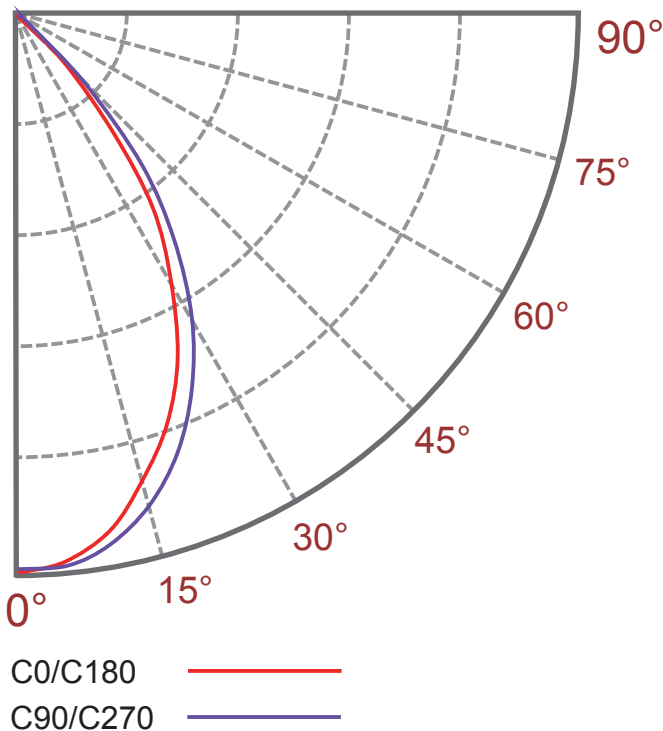

Zonal Lumen Summary

Zone (°)	Lumens	% Fixture
0-30	13,380	59.8%
0-40	19,198	85.5%
0-60	22,353	99.9%
0-90	22,375	100.0%
0-180	22,375	100.0%

ILX340 Series

LED Corrosive Area Lighting - 125Watt

Specification - Type V Frosted Long

Fixture Watts	125 W
Lumens (Total) *	20,375 lm
Efficacy *	163 lm / W
Number of LEDs & Driving Current	128@355mA
T _s - Solder Point Temp *	56°C / 133°F
L70 Rating @ T _a 25°C	> 140K hours
Operational Temperature (T _a)	-40° ~ 60°C / -40° ~ 140°F
Input Voltage	100~277VAC 47~63Hz Optional 200~480VAC
LED Model	Nichia / Lumileds / Cree
CRI	> 75
Lighting Control	Dimmable (0-10V, PWM)
Storage Temp. / Humidity	-40° ~ 80°C / -40° ~ 176°F / IP69K Rated Fixture
Transient Surge Protection	10kV / 5kA (L-L, L-G) Optional 20kV / 10kA
Warranty	7-Year Limited

* Test data @ T_a: 25°C. All lumen values have ±7% tolerance
NOTE: Light intensities measured directly below fixture

Light Distribution Curve

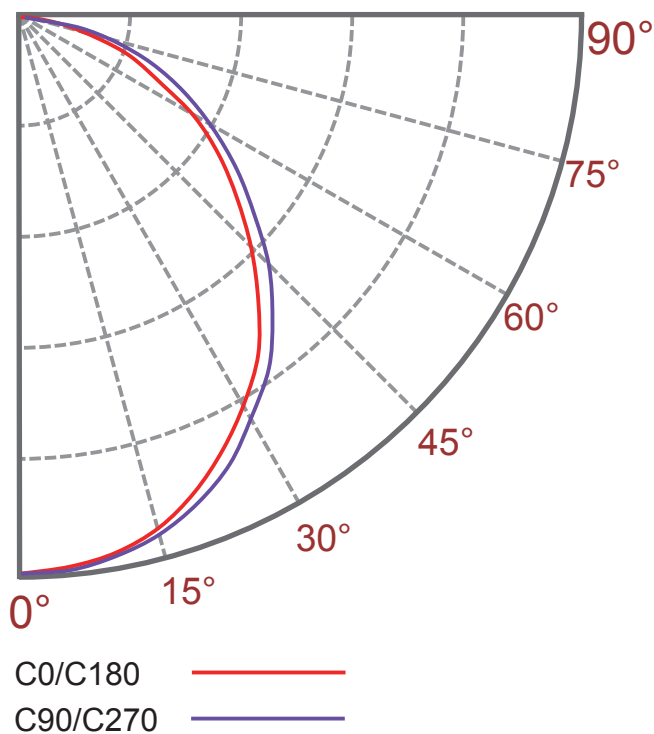

Zonal Lumen Summary

Zone (°)	Lumens	% Fixture
0-30	5,990	29.4%
0-40	9,658	47.4%
0-60	16,463	80.8%
0-90	20,314	99.7%
0-180	20,375	100.0%