

# LU0720 Series

LED Linear Utility Lighting



## Advantages of LU Series

- IP67 rated tri-proof (dust, vapor & water-proof) LED linear industrial utility light
- High efficacy fixture with up to 170 lm / W
- Flexible wattages and lengths ranging from 20 ~ 120Watt
- Robust design with extruded billet aluminum housing and hard UV coated polycarbonate lens & end-caps delivering an outstanding IK10 impact rating
- Glare free 155° wide angle optics reducing fixture count by up to 25%
- Lightweight design with accessible junction box for simplified installation
- 80 CRI for exceptional color rendition
- Optional smart motion sensing with soft dimming function
- Optional all-inclusive emergency battery backup system 10Watt / 90 minutes
- Versatile mounting options for all types of applications
- L70 ≥ 100,000 hours with 7-year limited warranty
- Designed and engineered in the USA

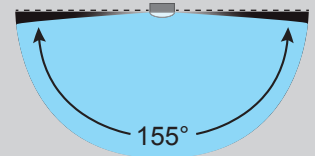

Wide Angle Optics

## Applications

- Manufacturing Plants
- Warehouses
- Cold Storage Facilities
- Parking structures
- Telecom Centers
- Clean Rooms
- Supermarkets



Years Warranty



Wet Location



Impact Resistance

# LU0720 Series

LED Linear Utility Lighting

## Mounting Options

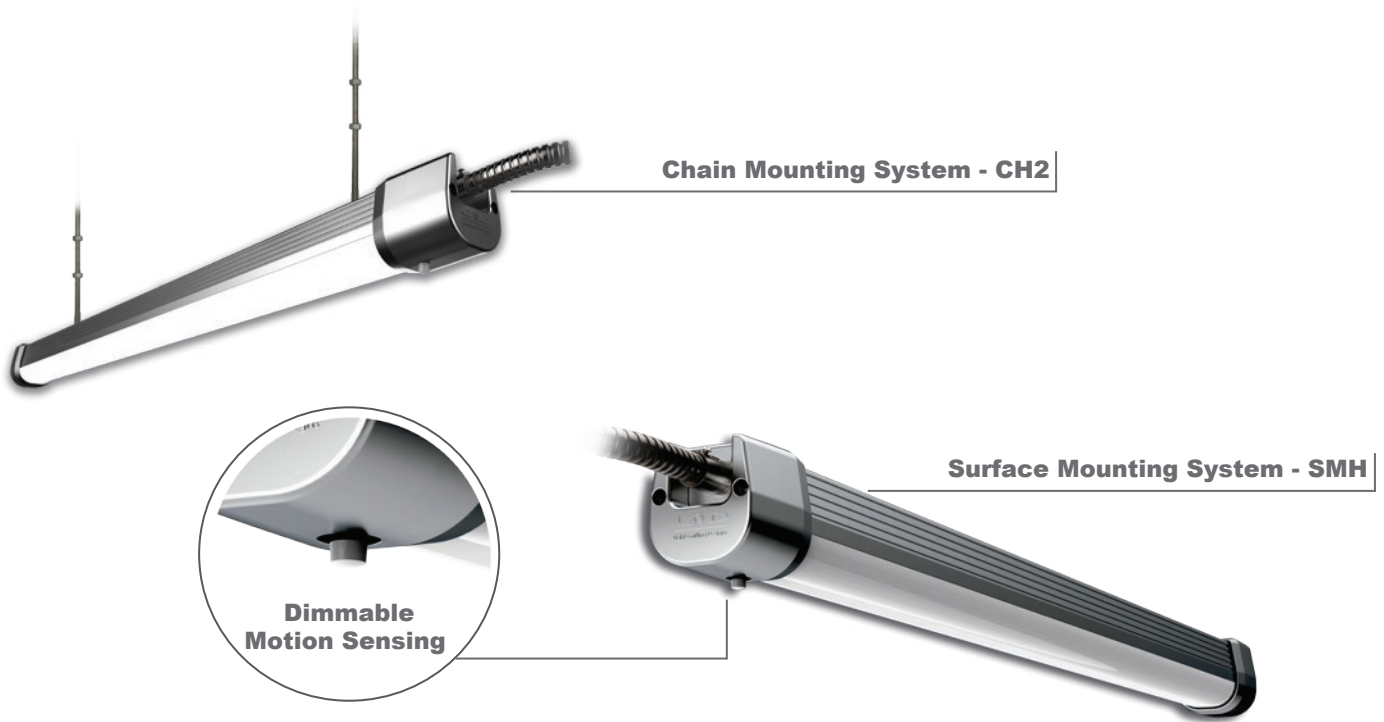

## Wiring Options

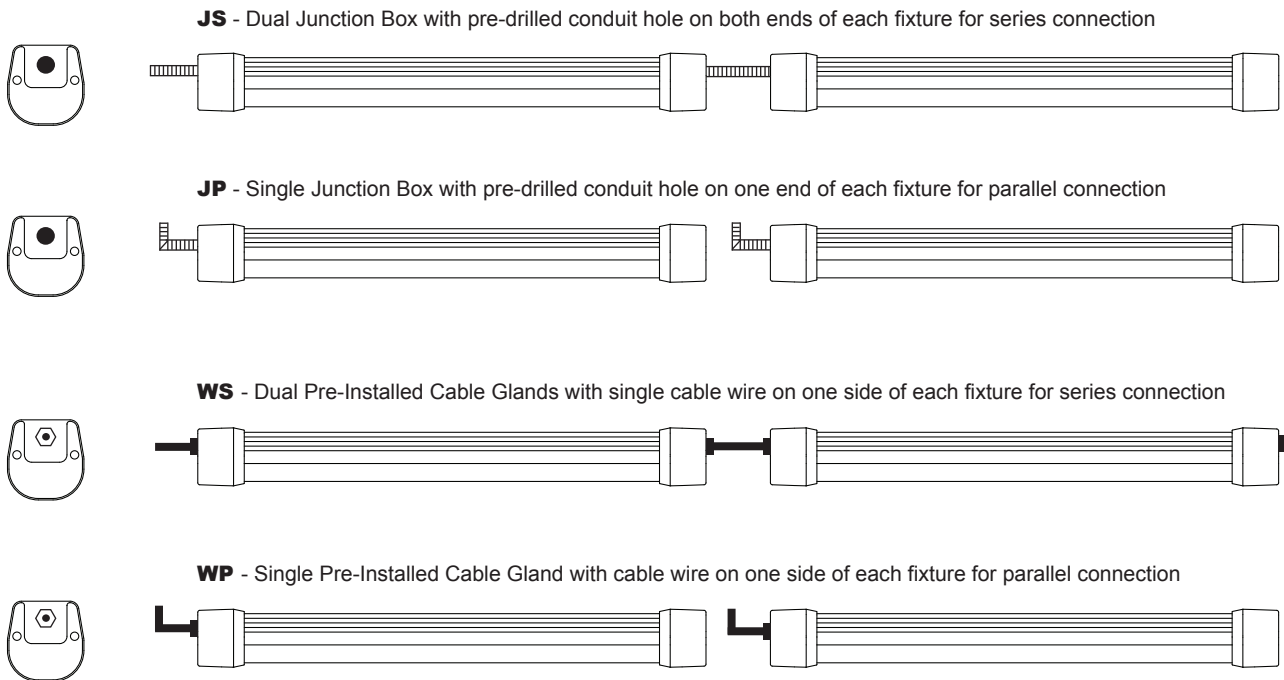

# LU0720 Series

LED Linear Utility Lighting - 20Watt

## Ordering Information

LU	Length & Wattage *	Wiring **	Optics	CCT	Driver & Control	Mounting ***
	0720 = 74cm / 29" / 20Watt 1040 = 111cm / 44" / 40Watt 1E40 = 111cm / 44" / 40/10Watt 1060 = 111cm / 44" / 60Watt 1E60 = 111cm / 44" / 60/10Watt 2080 = 211cm / 83" / 80Watt 2120 = 211cm / 83" / 120watt	JS = J-Box in Series JP = J-Box in Parallel WS = Cable in Series WP = Cable in Parallel	FL = Frosted Long CM = Clear Medium	30 = 3000K 40 = 4000K 50 = 5000K	ND = Non-Dimmable DM = Dimmable MS = Motion Sensor	SMH = Surface Mount CH2 = 2 Chain Mount

\* LU1E emergency battery back up is available in standard 40 and 60 Watt configurations with an all-inclusive charger, battery, indicator and test switch.

\*\* When ordering JS or JP Wiring options, please specify required conduit hole diameter.

\*\*\* Multi Mount system comes standard enabling surface, threaded rod and chain mounting.

## Example

Part Number	Part Description
LU0720-JSFL-50DM-SMH	LED Linear Utility Light / 74cm - 29" / 20Watt / 100-277VAC / J-Box in Series / Frosted Long / 5000K Cool White / Dimmable / Surface Mount

## External Dimensions

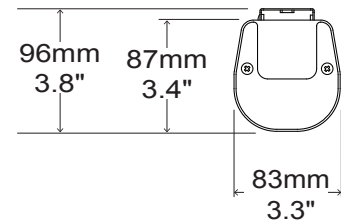
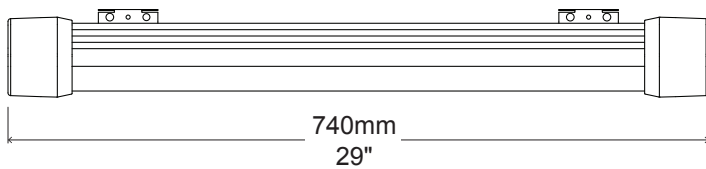

## Packaging Information

Case Quantity	Dimensions (LxWxH)	Weight
6	83 x 36 x 21 cm 32.7 x 14 x 8.3 in	13 kg 28.6 lbs



# LU0720 Series

## LED Linear Utility Lighting - 20Watt

### Specification - Clear Medium

Fixture Watts *	20 W
Lumens (Total) *	3,440 lm
Efficacy *	172 lm / W
Number of LEDs & Driving Current	104@65mA
T <sub>s</sub> - Solder Point Temp *	46°C / 115°F
L70 Rating @ T <sub>a</sub> 25°C	>110K hours
Light Beam Angle	155° @ 80% Flux
Operational Temperature (T <sub>a</sub> )	-40° ~ 55°C / -40° ~ 131°F
Input Voltage	100-277VAC 50~60Hz
LED Model	Lumileds / Nichia / Cree
CRI	>80
Lighting Control	Dimmable (0-10V, PWM) / Motion Sensor
Warranty	7-Year Limited
Storage Temperature / Humidity	-40° ~ 80°C / -40° ~ 176°F / IP67 Rated Fixture
Transient Surge Protection	6kV / 3kA ( L-L, L-G )

\* Test data @ T<sub>a</sub> 25°C. All lumen values have ±7% tolerance

\*\*LU1E emergency battery back up series is available in standard 40 and 60 Watt configurations with an all-inclusive inverter, indicator, and test switch.

### Light Distribution Curve

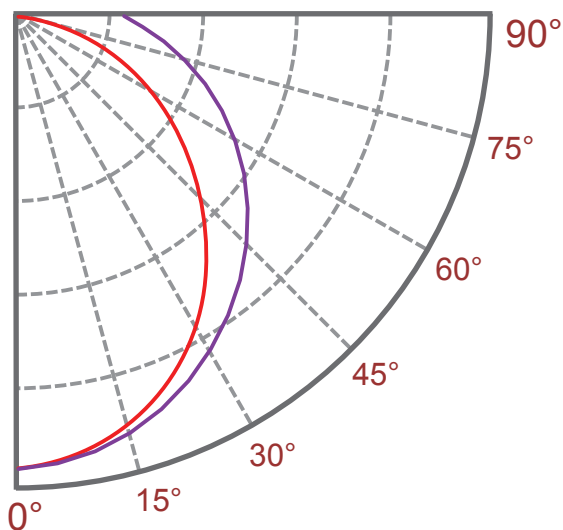

C0/C180 —  
 C90/C270 —

### Zonal Lumen Summary

Zone (°)	Lumens	% Fixture
0-30	770	22.4%
0-60	2246	65.3%
0-90	3143	91.4%
0-120	3398	98.8%
0-150	3437	99.9%
0-180	3440	100%

# LU0720 Series

LED Linear Utility Lighting - 20Watt

## Specification - Frosted Long

Fixture Watts *	20 W
Lumens (Total) *	3,200 lm
Efficacy *	160 lm / W
Number of LEDs & Driving Current	104@65mA
T <sub>s</sub> - Solder Point Temp *	47°C / 117°F
L70 Rating @ T <sub>a</sub> 25°C	>110K hours
Light Beam Angle	155° @ 80% Flux
Operational Temperature (T <sub>a</sub> )	-40° ~ 55°C / -40° ~ 131°F
Input Voltage	100-277VAC 50~60Hz
LED Model	Lumileds / Nichia / Cree
CRI	>80
Lighting Control	Dimmable (0-10V, PWM) / Motion Sensor
Warranty	7-Year Limited
Storage Temperature / Humidity	-40° ~ 80°C / -40° ~ 176°F / IP67 Rated Fixture
Transient Surge Protection	6kV / 3kA ( L-L, L-G )

\* Test data @ T<sub>a</sub> 25°C. All lumen values have ±7% tolerance

\*\*LU1E emergency battery back up series is available in standard 40 and 60 Watt configurations with an all-inclusive inverter, indicator, and test switch.

## Light Distribution Curve

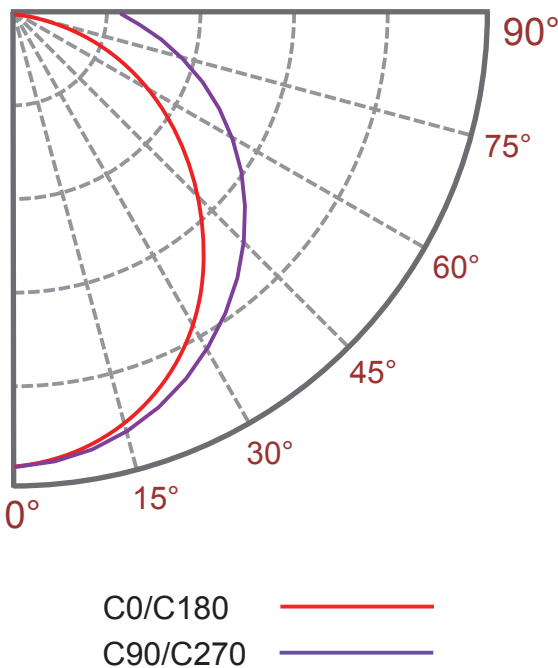

## Zonal Lumen Summary

Zone (°)	Lumens	% Fixture
0-30	716	22.4%
0-60	2089	65.3%
0-90	2923	91.4%
0-120	3161	98.8%
0-150	3197	99.9%
0-180	3200	100%