

LU208 Series

LED Linear Utility Lighting

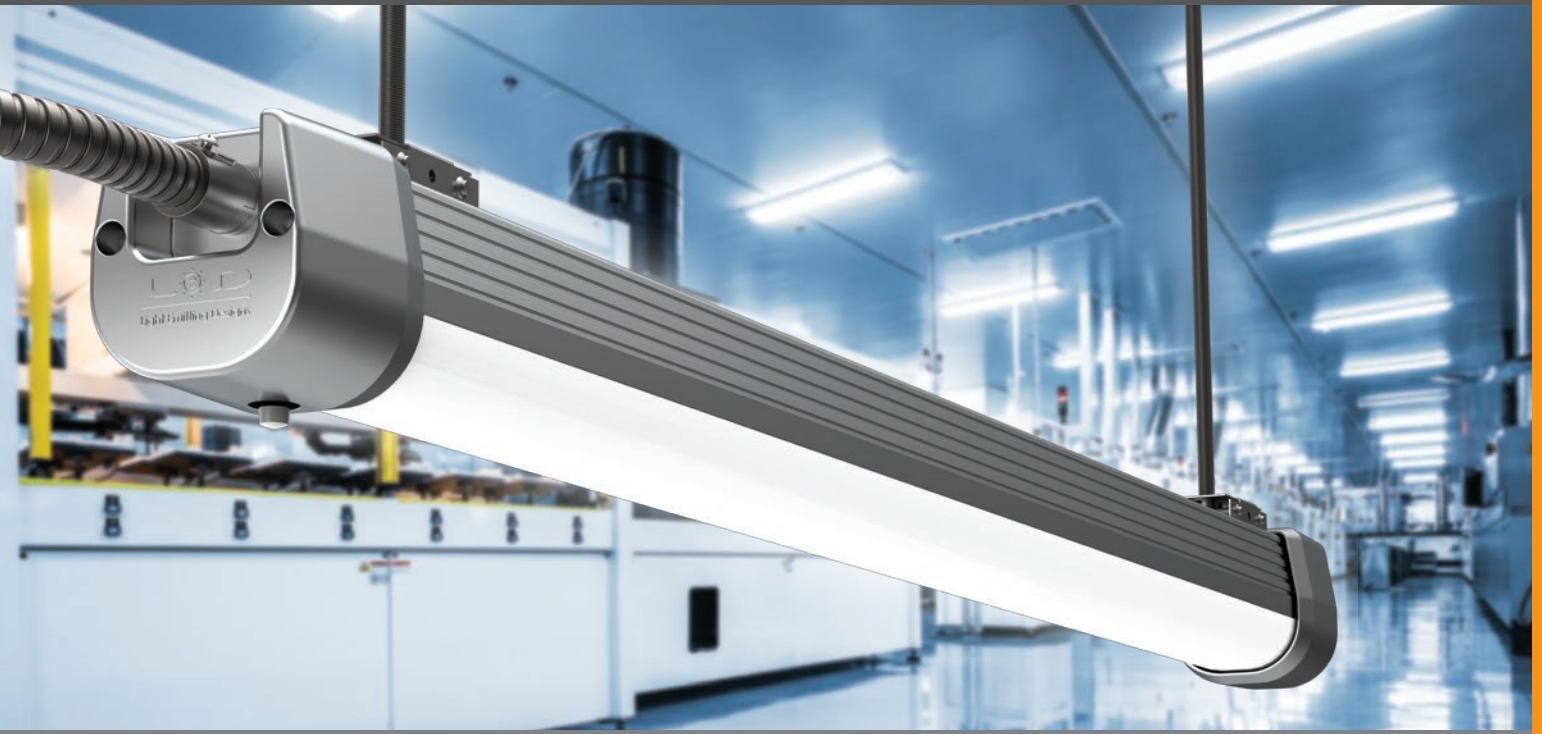

Advantages of LU Series

- IP67 rated tri-proof (dust, vapor & water-proof) LED linear industrial utility light
- High efficacy fixture with up to 170 lm / W
- Flexible wattages and lengths ranging from 20 ~ 120Watt
- Robust design with extruded billet aluminum housing and hard UV coated polycarbonate lens & end-caps delivering an outstanding IK10 impact rating
- Glare free 155° wide angle optics reducing fixture count by up to 25%
- Lightweight design with accessible junction box for simplified installation
- 80 CRI for exceptional color rendition
- Optional smart motion sensing with soft dimming function
- Optional all-inclusive emergency battery backup system 10Watt / 90 minutes
- Versatile mounting options for all types of applications
- L70 ≥ 100,000 hours with 7-year limited warranty
- Designed and engineered in the USA

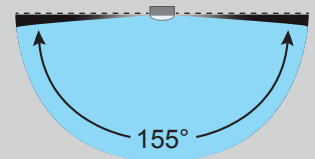

Wide Angle Optics

Applications

- Manufacturing Plants
- Warehouses
- Cold Storage Facilities
- Parking structures
- Telecom Centers
- Clean Rooms
- Supermarkets



Years Warranty



Wet Location



Impact Resistance

LU2080 Series

LED Linear Utility Lighting

Mounting Options

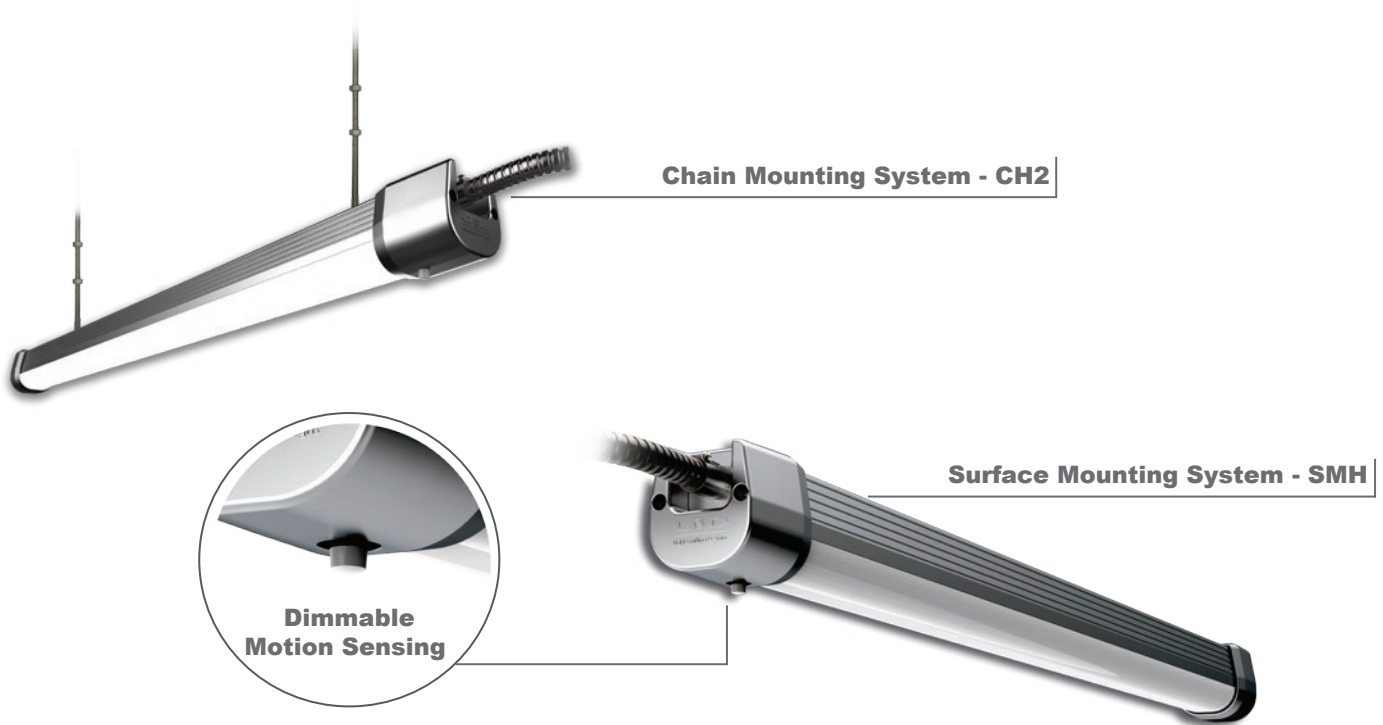

Wiring Options

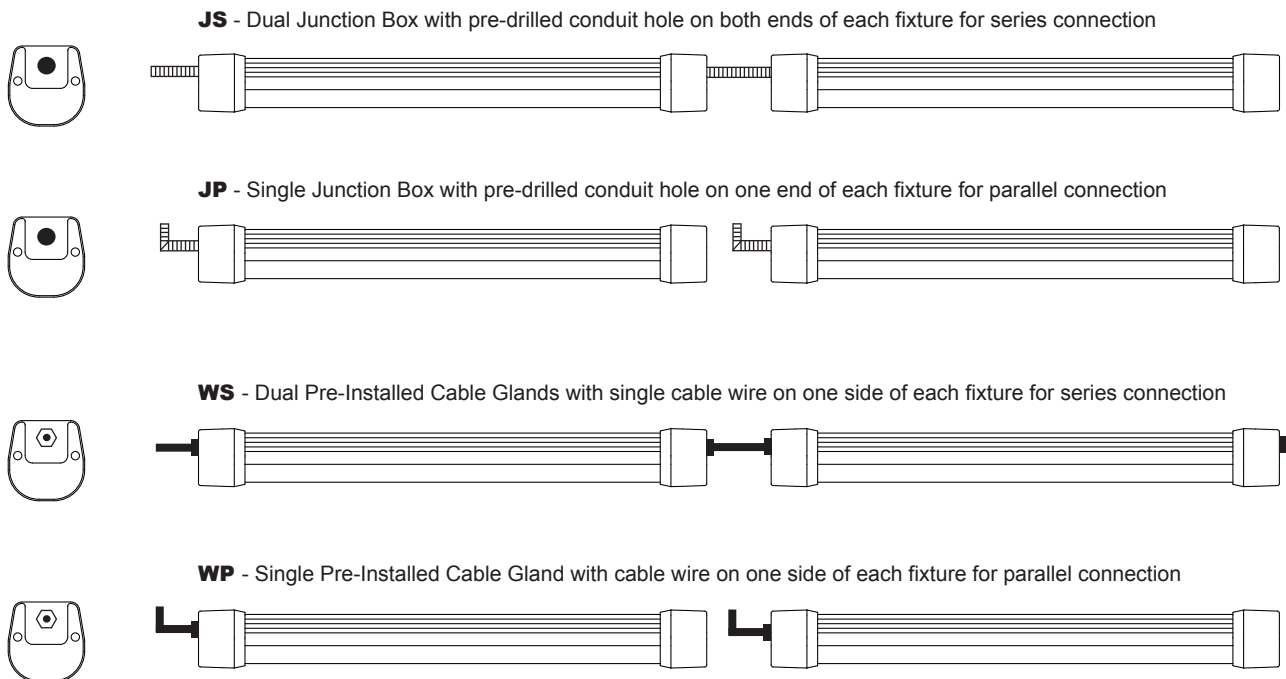

LU2080 Series

LED Linear Utility Lighting - 80Watt

Ordering Information

LU	Length & Wattage *	Wiring **	Optics	CCT	Driver & Control	Mounting ***
	0720 = 74cm / 29" / 20Watt 1040 = 111cm / 44" / 40Watt 1E40 = 111cm / 44" / 40/10Watt 1060 = 111cm / 44" / 60Watt 1E60 = 111cm / 44" / 60/10Watt 2080 = 211cm / 83" / 80Watt 2120 = 211cm / 83" / 120watt	JS = J-Box in Series JP = J-Box in Parallel WS = Cable in Series WP = Cable in Parallel	FL = Frosted Long CM = Clear Medium	30 = 3000K 40 = 4000K 50 = 5000K	ND = Non-Dimmable DM = Dimmable MS = Motion Sensor	SMH = Surface Mount CH2 = 2 Chain Mount

* LU1E emergency battery back up is available in standard 40 and 60 Watt configurations with an all-inclusive charger, battery, indicator and test switch.

** When ordering JS or JP Wiring options, please specify required conduit hole diameter.

*** Multi Mount system comes standard enabling surface, threaded rod and chain mounting.

Example

Part Number	Part Description
LU2080-JSFL-50DM-SMH	LED Linear Utility Light / 211cm - 83" / 80Watt / 100-277VAC / J-Box in Series / Frosted Long / 5000K Cool White / Dimmable / Surface Mount

External Dimensions

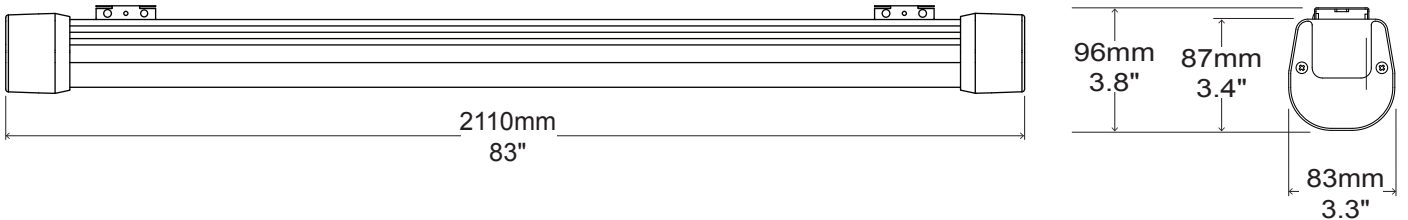

Packaging Information

Case Quantity	Dimensions (LxWxH)	Weight
4	217 x 24 x 21 cm 85.5 x 9.5 x 8.3 in	26.5 kg 58.4 lbs



LU2080 Series

LED Linear Utility Lighting - 80Watt

Specification - Clear Medium

Fixture Watts *	80 W
Lumens (Total) *	13,600 lm
Efficacy *	170 lm / W
Number of LEDs & Driving Current	416@65mA
T _s - Solder Point Temp *	53°C / 127°F
L70 Rating @ T _a 25°C	>100K hours
Light Beam Angle	155° @ 80% Flux
Operational Temperature (T _a)	-40° ~ 55°C / -40° ~ 131°F
Input Voltage	100-277VAC 50~60Hz
LED Model	Lumileds / Nichia / Cree
CRI	>80
Lighting Control	Dimmable (0-10V, PWM) / Motion Sensor
Warranty	7-Year Limited
Storage Temperature / Humidity	-40° ~ 80°C / -40° ~ 176°F / IP67 Rated Fixture
Transient Surge Protection	6kV / 3kA (L-L, L-G)

* Test data @ T_a 25°C. All lumen values have ±7% tolerance

**LU1E emergency battery back up series is available in standard 40 and 60 Watt configurations with an all-inclusive inverter, indicator, and test switch.

Light Distribution Curve

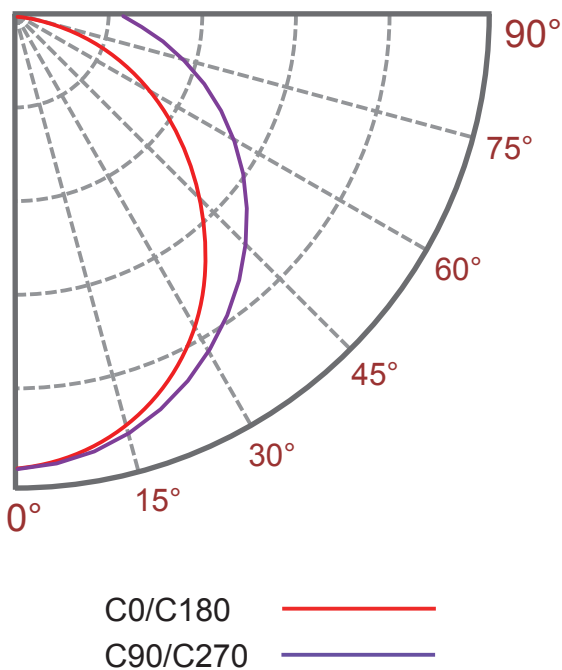

Zonal Lumen Summary

Zone (°)	Lumens	% Fixture
0-30	3044	22.4%
0-60	8878	65.3%
0-90	12424	91.4%
0-120	13434	98.8%
0-150	13586	99.9%
0-180	13600	100%

LU2080 Series

LED Linear Utility Lighting - 80Watt

Specification - Frosted Long

Fixture Watts *	80 W
Lumens (Total) *	12,480 lm
Efficacy *	156 lm / W
Number of LEDs & Driving Current	416@65mA
T _s - Solder Point Temp *	55°C / 131°F
L70 Rating @ T _a 25°C	>100K hours
Light Beam Angle	155° @ 80% Flux
Operational Temperature (T _a)	-40° ~ 55°C / -40° ~ 131°F
Input Voltage	100-277VAC 50~60Hz
LED Model	Lumileds / Nichia / Cree
CRI	>80
Lighting Control	Dimmable (0-10V, PWM) / Motion Sensor
Warranty	7-Year Limited
Storage Temperature / Humidity	-40° ~ 80°C / -40° ~ 176°F / IP67 Rated Fixture
Transient Surge Protection	6kV / 3kA (L-L, L-G)

* Test data @ T_a 25°C. All lumen values have ±7% tolerance

**LU1E emergency battery back up series is available in standard 40 and 60 Watt configurations with an all-inclusive inverter, indicator, and test switch.

Light Distribution Curve

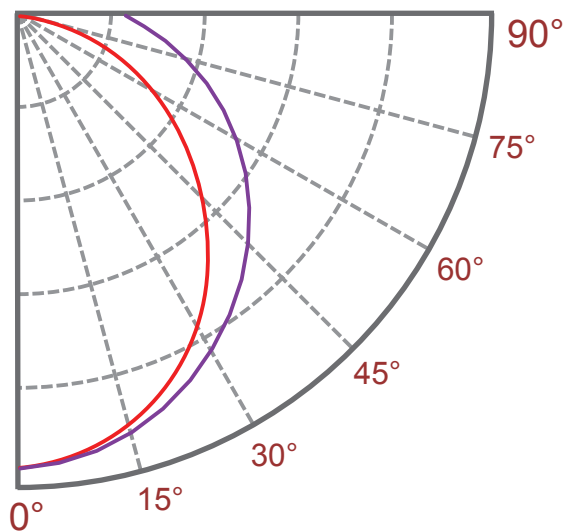

C0/C180 ————
C90/C270 ————

Zonal Lumen Summary

Zone (°)	Lumens	% Fixture
0-30	2794	22.4%
0-60	8146	65.3%
0-90	11402	91.4%
0-120	12328	98.8%
0-150	12468	99.9%
0-180	12480	100%