

RWLII Series

LED Roadway Lighting



Advantages of RWLII

- Available in 100 ~ 220 Watt configurations with various optics
- Ultra-bright high efficacy up to 170 lm / W
- Proprietary reflector optics enabling glare-free uniform lighting, eliminating the need for costly and fragile plastic lenses
- Advanced thermal technology enables low LED junction temperatures (Tj) for maintenance free long life
- IP68 rated tri-proof (dust, vapor & water-proof) luminaire
- Dark Sky compliant / full cut-off optics
- Available with versatile mounting options for various street lighting applications
- Titanium rated high efficiency LED driver with smart circuitry
- L70 ≥ 150,000 hours with an exceptional 10-year limited warranty
- Designed and engineered in the USA



Years Warranty



Wet Location



Impact Resistance

Applications

- Residential Streets
- Urban Roads
- Motorways
- Boulevards
- Perimeters
- Parking Lots

Optic Options

02 - Type II / asymmetric for street and pedestrian walkway applications

S - Short

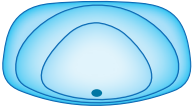

M - Medium

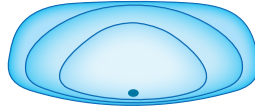

R5 - Type V Round / symmetric for street, parking lot and pedestrian walkway applications

M - Medium

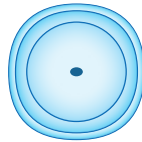

S5 - Type V Square / symmetric for street, parking lot and pedestrian walkway applications

S - Short

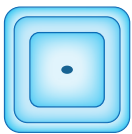

F5 - Type V Opaque - Frosted / symmetric for ultra uniform & low glare applications

L - Long

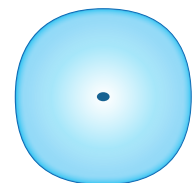

RWLII Series

LED Roadway Lighting - 150Watt

Ordering Information

RWLII	Wattage	Voltage	Optics	Pitch	CCT	Driver & Control
	100 = 100W 125 = 125W 150 = 150W 185 = 185W 220 = 220W	UV = 100-277VAC HV = 200-480VAC DV = 127-390VDC	02 = Type II R5 = Type V Round S5 = Type V Square F5 = Type V Frosted	S = Short M = Medium L = Long	30 = 3000K 40 = 4000K 50 = 5000K	ND = Non-Dimmable DM = Dimmable

NOTE: Gray is the standard exterior color.

Example

Part Number	Part Description
RWLII150UV-R5M-50DM	LED Roadway Light / 150 Watt / 100-277VAC / Type II Round / Medium Pitch / 5000K Cool White / Dimmable

External Dimensions

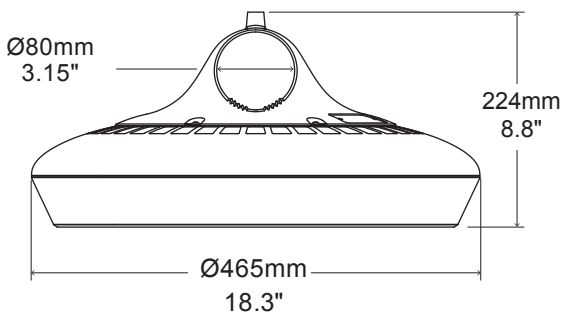

Packaging Information

Quantity	Dimensions (LxWxH)	Weight
1	50 x 50 x 31 cm 19.7 x 19.7 x 12.2 in	13 kg 28.6 lbs



RWLII Series

LED Roadway Lighting - 150Watt

Specification - Type II Short

Fixture Watts	150 W
Lumens (Total)*	21,450 lm
Efficacy *	143 lm / W
Number of LEDs & Driving Current	96@515mA
T _s - Solder Point Temp *	59°C / 138°F
L70 Rating @ T _a 25°C	>175K hours
Operational Temperature (T _a)	-40° ~ 55°C / -40° ~ 131°F
Input Voltage	100~277VAC 47~63Hz Optional 200~480VAC / 127~390VDC
LED Model	Lumileds / Nichia / Cree
CRI	>75
Lighting Control	Dimmable (0-10V, PWM)
Warranty	10-Year Limited
Storage Temp. / Humidity	-50° ~ 80°C / -58° ~ 176°F / IP68 Rated Fixture
Transient Surge Protection	10kV / 5kA (L-L, L-G) Optional 20kV / 10kA

* Test data @ T_a: 25°C. All lumen values have ±7% tolerance
 NOTE: Light intensities measured directly below fixture

Light Distribution Curve

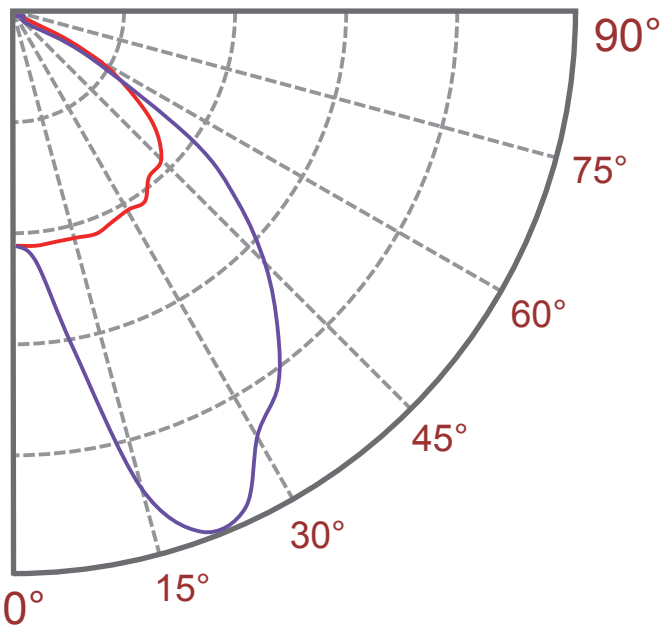

C0/C180 —
 C90/C270 —

Zonal Lumen Summary

Zone (°)	Lumens	% Fixture
0-30	.6,692	31.2%
0-40	11,540	53.8%
0-60	20,056	93.5%
0-90	21,429	99.9%
0-180	21,450	100.0%

RWLII Series

LED Roadway Lighting - 150Watt

Specification - Type II Medium

Fixture Watts	150 W
Lumens (Total)*	20,700 lm
Efficacy *	138 lm / W
Number of LEDs & Driving Current	96@515mA
T _s - Solder Point Temp *	59°C / 138°F
L70 Rating @ T _a 25°C	>175K hours
Operational Temperature (T _a)	-40° ~ 55°C / -40° ~ 131°F
Input Voltage	100~277VAC 47~63Hz Optional 200~480VAC / 127~390VDC
LED Model	Lumileds / Nichia / Cree
CRI	>75
Lighting Control	Dimmable (0-10V, PWM)
Warranty	10-Year Limited
Storage Temp. / Humidity	-50° ~ 80°C / -58° ~ 176°F / IP68 Rated Fixture
Transient Surge Protection	10kV / 5kA (L-L, L-G) Optional 20kV / 10kA

* Test data @ T_a: 25°C. All lumen values have ±7% tolerance
 NOTE: Light intensities measured directly below fixture

Light Distribution Curve

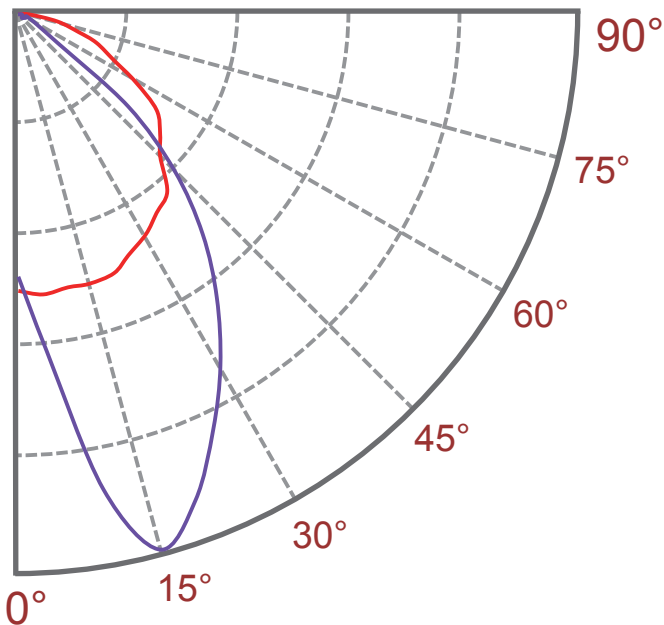

C0/C180 ————
 C90/C270 ————

Zonal Lumen Summary

Zone (°)	Lumens	% Fixture
0-30	6,914	33.4%
0-40	10,971	53.0%
0-60	17,657	85.3%
0-90	20,638	99.7%
0-180	20,700	100.0%

RWLII Series

LED Roadway Lighting - 150Watt

Specification - Type V Round Medium

Fixture Watts	150 W
Lumens (Total)*	22,800 lm
Efficacy *	152 lm / W
Number of LEDs & Driving Current	112@440mA
T _s - Solder Point Temp *	56°C / 133°F
L70 Rating @ T _a 25°C	>175K hours
Operational Temperature (T _a)	-40° ~ 55°C / -40° ~ 131°F
Input Voltage	100~277VAC 47~63Hz Optional 200~480VAC / 127~390VDC
LED Model	Lumileds / Nichia / Cree
CRI	>75
Lighting Control	Dimmable (0-10V, PWM)
Warranty	10-Year Limited
Storage Temp. / Humidity	-50° ~ 80°C / -58° ~ 176°F / IP68 Rated Fixture
Transient Surge Protection	10kV / 5kA (L-L, L-G) Optional 20kV / 10kA

* Test data @ T_a: 25°C. All lumen values have ±7% tolerance
 NOTE: Light intensities measured directly below fixture

Light Distribution Curve

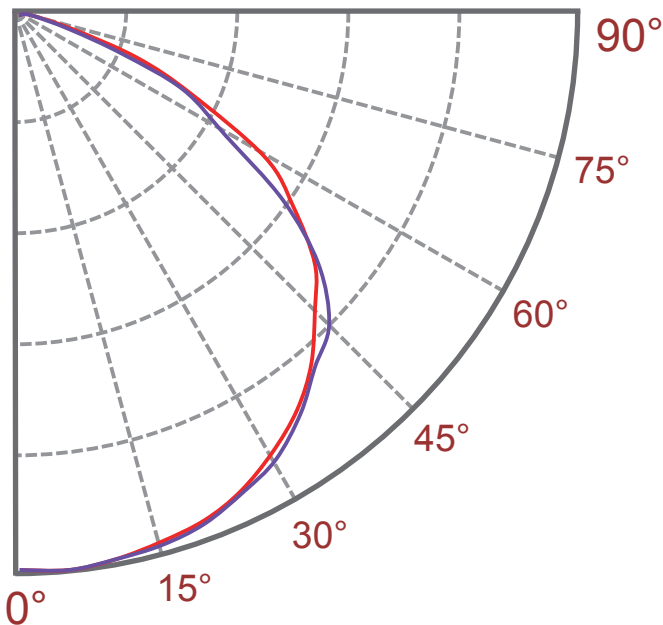

C0/C180 —
 C90/C270 —

Zonal Lumen Summary

Zone (°)	Lumens	% Fixture
0-30	6,270	27.5%
0-40	10,534	46.2%
0-60	19,289	84.6%
0-90	21,156	100.0%
0-180	22,800	100.0%

RWLII Series

LED Roadway Lighting - 150Watt

Specification - Type V Square Short

Fixture Watts	150 W
Lumens (Total)*	21,450 lm
Efficacy *	143 lm / W
Number of LEDs & Driving Current	112@440mA
T _s - Solder Point Temp *	57°C / 135°F
L70 Rating @ T _a 25°C	>175K hours
Operational Temperature (T _a)	-40° ~ 55°C / -40° ~ 131°F
Input Voltage	100~277VAC 47~63Hz Optional 200~480VAC / 127~390VDC
LED Model	Lumileds / Nichia / Cree
CRI	>75
Lighting Control	Dimmable (0-10V, PWM)
Warranty	10-Year Limited
Storage Temp. / Humidity	-50° ~ 80°C / -58° ~ 176°F / IP68 Rated Fixture
Transient Surge Protection	10kV / 5kA (L-L, L-G) Optional 20kV / 10kA

* Test data @ T_a: 25°C. All lumen values have ±7% tolerance
 NOTE: Light intensities measured directly below fixture

Light Distribution Curve

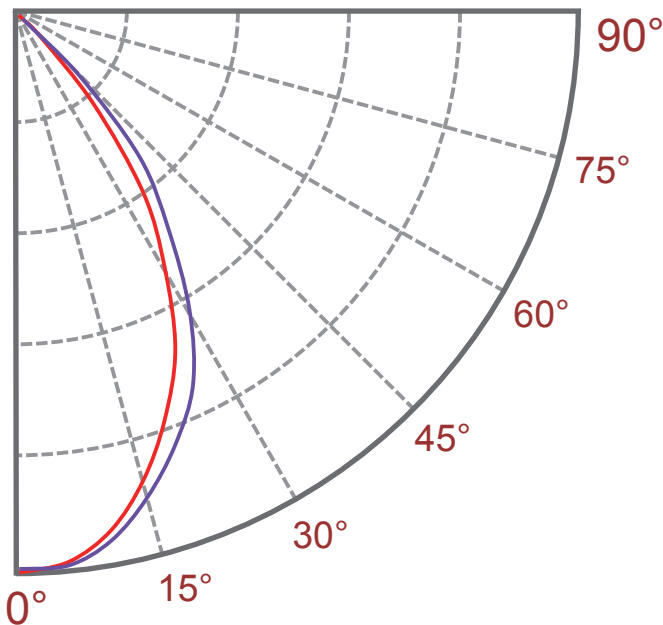

C0/C180 —
 C90/C270 —

Zonal Lumen Summary

Zone (°)	Lumens	% Fixture
0-30	12,891	60.1%
0-40	18,447	86.0%
0-60	21,364	99.6%
0-90	21,450	100.0%
0-180	21,450	100.0%

RWLII Series

LED Roadway Lighting - 150Watt

Specification - Type V Frosted Long

Fixture Watts	150 W
Lumens (Total)*	19,500 lm
Efficacy *	130 lm / W
Number of LEDs & Driving Current	112@440mA
T _s - Solder Point Temp *	56°C / 133°F
L70 Rating @ T _a 25°C	>175K hours
Operational Temperature (T _a)	-40° ~ 55°C / -40° ~ 131°F
Input Voltage	100~277VAC 47~63Hz Optional 200~480VAC / 127~390VDC
LED Model	Lumileds / Nichia / Cree
CRI	>75
Lighting Control	Dimmable (0-10V, PWM)
Warranty	10-Year Limited
Storage Temp. / Humidity	-50° ~ 80°C / -58° ~ 176°F / IP68 Rated Fixture
Transient Surge Protection	10kV / 5kA (L-L, L-G) Optional 20kV / 10kA

* Test data @ T_a: 25°C. All lumen values have ±7% tolerance
 NOTE: Light intensities measured directly below fixture

Light Distribution Curve

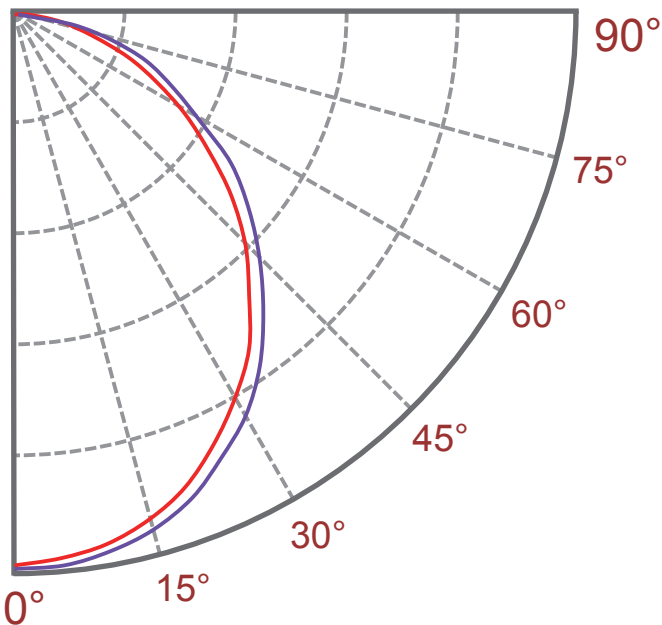

C0/C180 ————
 C90/C270 ————

Zonal Lumen Summary

Zone (°)	Lumens	% Fixture
0-30	5,733	29.4%
0-40	9,243	47.4%
0-60	15,737	80.7%
0-90	19,422	99.6%
0-180	19,500	100.0%